

## Montagebeispiel | Assembly example CO ST 70

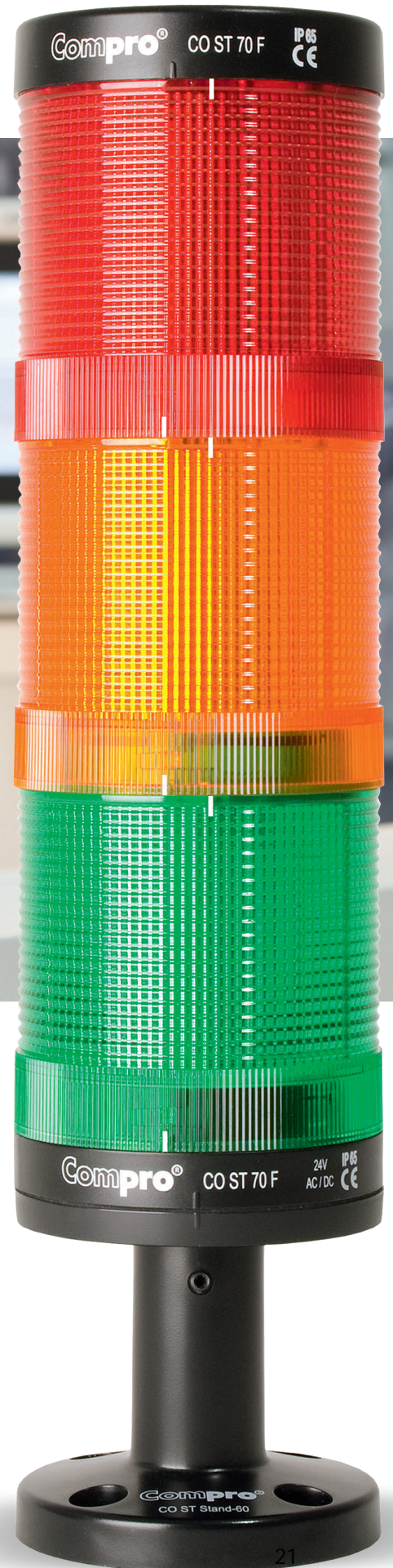

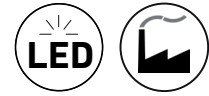



## CO ST 70 RGBA 2F

- LED-MULTICOLOUR-SIGNALSÄULE (D 70 mm)
- | 4 Grundfarben in einem Element
- | 2 Einstellungen (2F)
- | Verschiedene Kombinationen inklusive Aufbausirene möglich
- | Auf 230 V erweiterbar
- | Dauer- /Blinklicht



## CO ST 70 RGBA 2F

- LED-MULTICOLOUR SIGNAL TOWER (D 70 mm)
- | 4 basic colours in one element
- | 2 settings (2F)
- | Various combinations possible
- | Expandable to 230 V
- | Continuous & indicate flash light



Abbildung mit Zubehör  
Illustration with accessories

### SPEZIFIKATIONEN | SPECIFICATIONS

Model	CO ST 70 RGBA 2F
Spannungsbereich   Operating voltage	24 V AC/DC
Stromaufnahme   Current consumption	80 mA
Schutzklasse   IP rating	IP65
Temperaturbereich   Operating temperature	-25 °C bis +70 °C   -25 °C to +70 °C
LED Farben   LED colours	rot, gelb, grün oder blau   red, yellow, green or blue
Kalottenfarben   Lens colours	klar   clear
Gehäusefarben   Body colours	schwarz   black
Material   Construction	PC
Einstellungen   Settings	Dauerlicht, Blinklicht   continuous light, indicate flash light

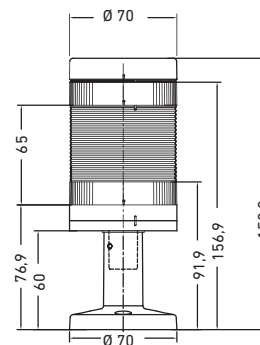

Artikel /  
Article

Bestellnummer /  
Order number

Artikel /  
Article

Bestellnummer /  
Order number

## PRODUKTVARIANTEN / PRODUCT VARIANT

LED-MULTICOLOUR SIGNALSÄULE [D 70 mm] - 2 FUNKTIONEN /  
LED-MULTICOLOUR SIGNAL TOWER [D 70 mm] - 2 FUNCTIONS

	LED Element CO ST 70, 2F, RGBA / LED Element CO ST 70, 2F, RGBA	6108413600
	Base 70 mm mit Gewinde und Deckel / Base 70 mm with thread and cap	6109173070
	Power Modul CO ST 70 inkl. 230V-Base / Power Module CO ST 70 incl. 230V-Base	6109278060
	Aufbausirene CO ST 70 / Sonder CO ST 70	6109374000

## ZUBEHÖR / ACCESSORIES

	Gelenkfuss / Stand Foldable	6109070000
	Montagefuss 60 mm / Stand 60 mm	6109570000
	Montagefuss 110 mm / Stand 110 mm	6109670000
	Montagewinkel / Wall Mount	6109770000
	Verlängerungsrohr 250 mm / Extension Tube 250 mm	6109870000
	CO ST Schraubenset PM / CO ST Screwset PM	6109070060
	Rohr mit Verschraubung / Panel Mount	6109970000

Produktkatalog / catalog



Bedienungsanleitung / user manual







Artikel /  
Article



Bestellnummer /  
Order number

Artikel /  
Article



Bestellnummer /  
Order number

## PRODUKTVARIANTEN / PRODUCT VARIANT

LED-SIGNALSÄULE (D 70 mm) /  
LED-SIGNAL TOWER (D 70 mm)

	Base 70 mm mit Gewinde und Deckel / Base 70 mm with thread and cap	6109173070
	Aufbausirene CO ST 70 / Sounder CO ST 70	6109374000
	LED Element CO ST 70, 2F, rot / LED Element CO ST 70, 2F, red	6108423200

## BESTELLNUMMERN ZUBEHÖR

	Montagefuss 60 mm / Stand 60 mm	6109570000
	Montagefuss 110 mm / Stand 110 mm	6109670000
	Montagewinkel / Wall Mount	6109770000
	Verlängerungsrohr 250 mm / Extension Tube 250 mm	6109870000
	Rohr mit Verschraubung / Panel Mount	6109970000
	CO ST Schraubenset PM / CO ST Screwset PM	6109070060

Produktkatalog / catalog



# ZUBEHÖR



**Model CO ST STAND 60 oder 110**

- MONTAGEFUSS | STAND
- ABS
- Höhe | height 60 / 110 mm
- No. 6109570000 [60 mm]
- No. 6109570000 [110 mm]



**Model CO ST WM**

- MONTAGEWINKEL | WALL MOUNT
- ABS
- Höhe | height 115 mm
- No. 6109770000



**Model CO ST PM SET  
SCHRAUBENSET | SCREW SET**

- Mutter und Unterlegscheiben |  
Nut and washers
- No. 6109070060



**Model CO ST STAND F**

- GELENKFUSS |  
STAND FOLDABLE
- Gusseisen | cast iron
- Höhe | height 119,4 mm
- No. 6109670000



**Model CO ST TUBE-  
VERLÄNGERUNGSRÖHR |  
EXTENTIONS TUBE**

- ABS
- Höhe | height 250 mm
- No. 6109870000



**Model CO ST PM**

- ROHR MIT VERSCHRAUBUNG |  
PANEL MOUNT
- ABS
- Höhe | height 70 mm
- No. 6109870000



# MONTAGEFUSS 60 mm STAND 60 mm

ZUBEHÖR  
ACCESSORIES

LED-SIGNALSÄULEN  
LED-SIGNAL TOWERS

## SPEZIFIKATIONEN | SPECIFICATIONS

<b>Model</b>	<b>STAND 60 mm</b>
Gehäusefarben   Body colours	schwarz   black
Material   Construction	ABS   ABS

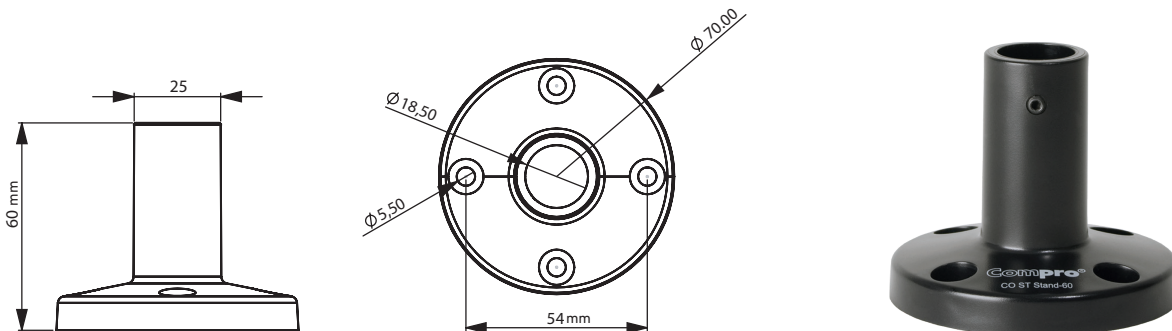

### BESTELLNUMMERN / ORDER NUMBERS

	Montagefuß 60 mm / Stand 60 mm	6109570000
---	-----------------------------------	------------

### BESTELLNUMMERN ZUBEHÖR ORDER NUMBERS ACCESSORIES

	Gelenkfuß / Stand Foldable	6109070000
	Montagefuß 110 mm / Stand 110 mm	6109670000
	Montagewinkel / Wall Mount	6109770000
	Verlängerungsrohr 250 mm / Extension Tube 250 mm	6109870000
	CO ST Schraubenset PM / CO ST Screwset PM	6109070060
	Rohr mit Verschraubung / Panel Mount	6109970000