

Montagebeispiel | Assembly example CO ST 40

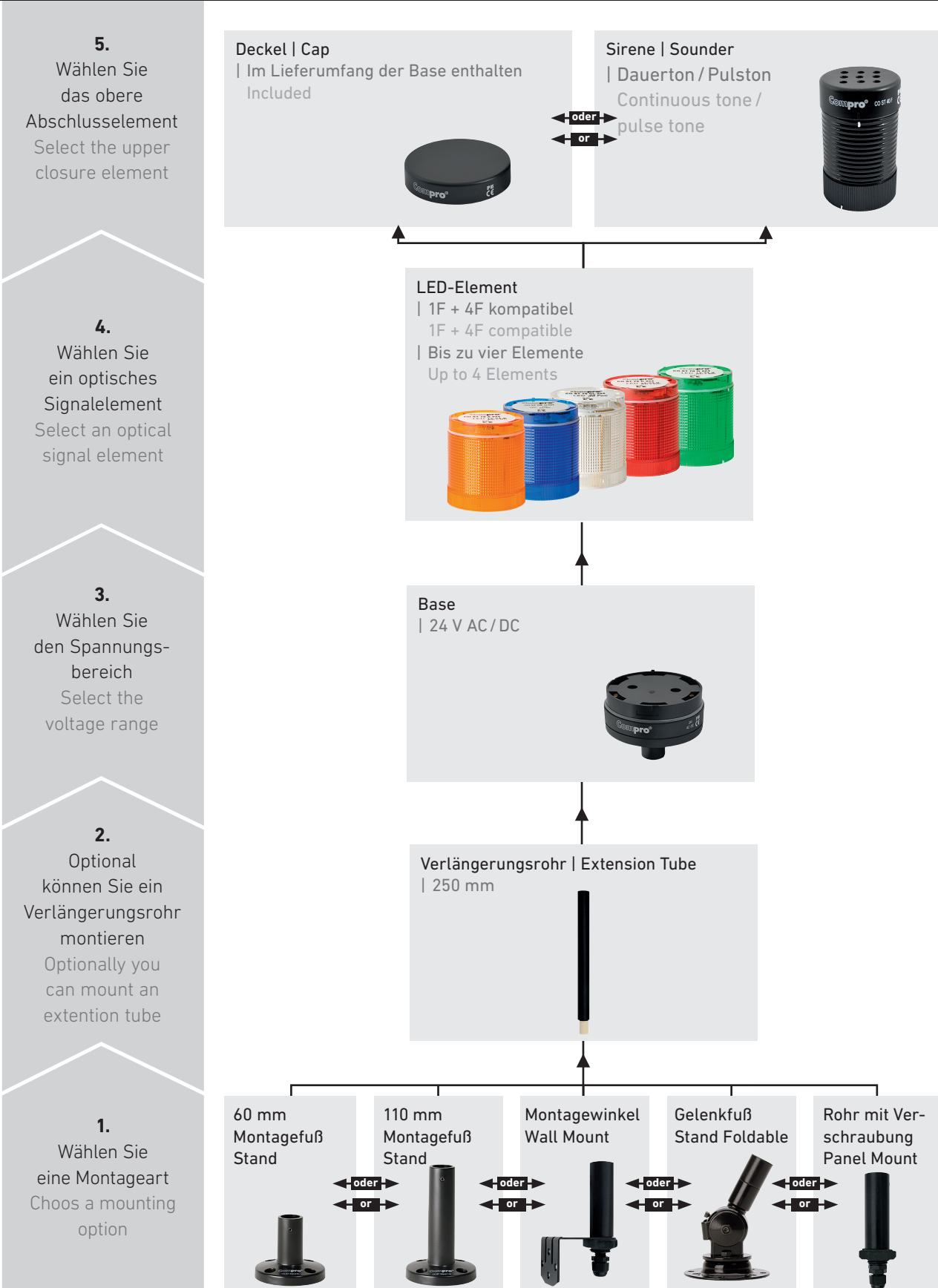

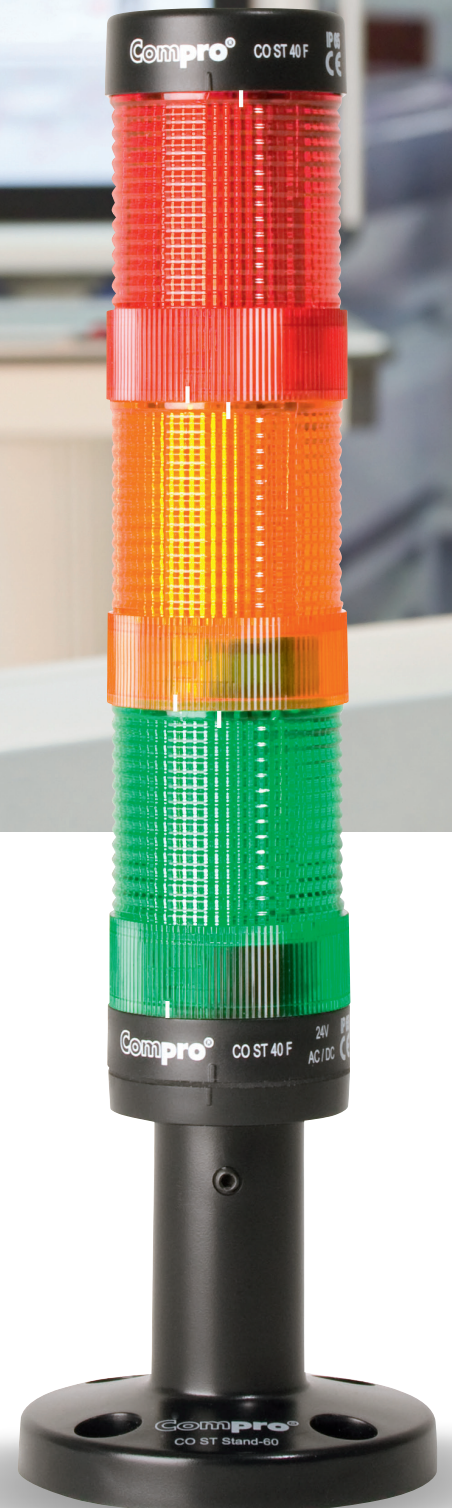

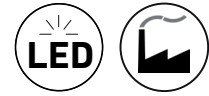

CO ST 40 1F

- LED-SIGNALSÄULEN [D 40 mm]
- | Verschiedene Kombinationen inklusive Aufbausirene möglich
- | 1 Einstellung (1F)
- | Schlagfestes Gehäuse
- | UV-beständig



CO ST 40 1F

- LED-SIGNAL TOWER [D 40 mm]
- | Various combinations with sounder version possible
- | 1 setting (1F)
- | Impact-proof case
- | UV-resistant

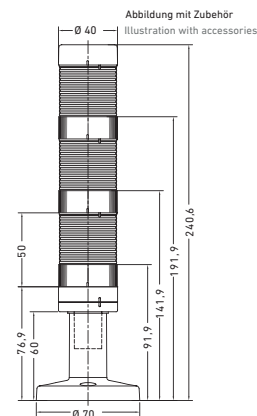

SPEZIFIKATIONEN | SPECIFICATIONS

Model	CO ST 40 1F
Spannungsbereich Operating voltage	24 V AC/DC
Stromaufnahme Current consumption	45 mA
Schutzklasse IP rating	IP65
Temperaturbereich Operating temperature	-25 °C bis +70 °C -25 °C to +70 °C
LED Farben LED colours	rot, gelb, grün, blau oder klar red, amber, green, blue or clear
Kalottenfarben Lens colours	rot, gelb, grün, blau oder klar red, amber, green, blue or clear
Gehäusefarben Body colours	schwarz black
Material Construction	PC
Einstellungen Settings	Dauerlicht continuous light



Artikel /
Article







Bestellnummer /
Order number

Artikel /
Article

Bestellnummer /
Order number

PRODUKTVARIANTEN / PRODUCT VARIANT

LED-SIGNALSÄULEN [D 40 mm] - 4 FUNKTIONEN /
LED SIGNAL TOWER [D 40 mm] - 4 FUNCTIONS

	LED Element CO ST 40, 1F, rot / LED Element CO ST 40, 1F, red	6117423200
	LED Element CO ST 40, 1F, gelb / LED Element CO ST 40, 1F, amber	6117433300
	LED Element CO ST 40, 1F, grün / LED Element CO ST 40, 1F, green	6117443400
	LED Element CO ST 40, 1F, blau / LED Element CO ST 40, 1F, blue	6117453500
	LED Element CO ST 40, 1F, klar / LED Element CO ST 40, 1F, clear	6117413100
	Base 40 mm mit Deckel / Base 40 mm with cap	6119170000
	Aufbausirene CO ST 40 / Sounder CO ST 40	6119373000

ZUBEHÖR / ACCESSORIES

	Gelenkfuss / Stand Foldable	6109070000
	Montagefuss 60 mm / Stand 60 mm	6109570000
	Montagefuss 110 mm / Stand 110 mm	6109670000
	Montagewinkel / Wall Mount	6109770000
	Verlängerungsrohr 250 mm / Extension Tube 250 mm	6109870000

Produktkatalog / catalog



Bedienungsanleitung / user manual





CO ST 40 4F

- LED-SIGNALSÄULEN [D 40 mm]
- | Verschiedene Kombinationen inklusive Aufbausirene möglich
- | 4 Einstellungen (4F)
- | Schlagfestes Gehäuse
- | UV-beständig



CO ST 40 4F

- LED-SIGNAL TOWER [D 40 mm]
- | Various combinations with sounder version possible
- | 4 setting (4F)
- | Impact-proof case
- | UV-resistant

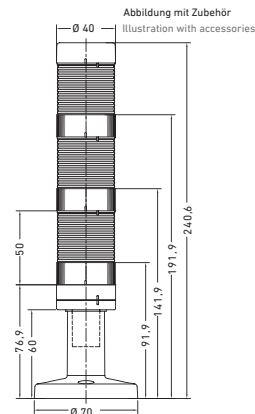

SPEZIFIKATIONEN | SPECIFICATIONS

Model	CO ST 40 4F
Spannungsbereich Operating voltage	12-24 V AC/DC
Stromaufnahme Current consumption	80 mA
Schutzklasse IP rating	IP65
Temperaturbereich Operating temperature	-25 °C bis +70 °C -25 °C to +70 °C
LED Farben LED colours	rot, gelb, grün, blau oder klar red, amber, green, blue or clear
Kalottenfarben Lens colours	rot, gelb, grün, blau oder klar red, amber, green, blue or clear
Gehäusefarben Body colours	schwarz black
Material Construction	PC
Einstellungen Settings	Dauerlicht, Blitzlicht, Doppelblitz, Rundumlicht continuous light, flash light ...



Artikel /
Article







Bestellnummer /
Order number

Artikel /
Article





Bestellnummer /
Order number

PRODUKTVARIANTEN / PRODUCT VARIANT

LED-SIGNALSÄULEN [D 40 mm] - 4 FUNKTIONEN /
LED SIGNAL TOWER [D 40 mm] - 4 FUNCTIONS

	LED Element CO ST 40, 4F, rot / LED Element CO ST 40, 4F, red	6117422200
	LED Element CO ST 40, 4F, gelb / LED Element CO ST 40, 4F, amber	6117432300
	LED Element CO ST 40, 4F, grün / LED Element CO ST 40, 4F, green	6117442400
	LED Element CO ST 40, 4F, blau / LED Element CO ST 40, 4F, blue	6117452500
	LED Element CO ST 40, 4F, klar / LED Element CO ST 40, 4F, clear	6117412100
	Base 40 mm mit Deckel / Base 40 mm with cap	6119170000
	Aufbausirene CO ST 40 / Sounder CO ST 40	6119373000

ZUBEHÖR / ACCESSORIES

	Gelenkfuss / Stand Foldable	6109070000
	Montagefuss 60 mm / Stand 60 mm	6109570000
	Montagefuss 110 mm / Stand 110 mm	6109670000
	Montagewinkel / Wall Mount	6109770000
	Verlängerungsrohr 250 mm / Extension Tube 250 mm	6109870000

Produktkatalog / catalog



Bedienungsanleitung / user manual





AUFBAUSIRENE

- LED-SIGNALSÄULEN (D 40 mm)
- | 2 auswählbare Töne
- | Schlagfestes Gehäuse
- | UV-beständig



SOUNDER

- LED-SIGNAL TOWER (D 40 mm)
- | 2 tones selectable
- | Impact-proof case
- | UV-resistant

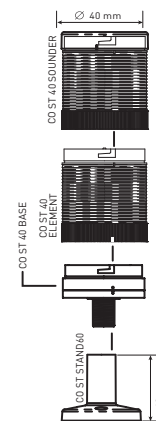

SPEZIFIKATIONEN | SPECIFICATIONS

Model	AUFBAUSIRENE
Spannungsbereich Operating voltage	24 V AC/DC
Stromaufnahme Current consumption	30 mA
Lautstärke Sound output	75 dB(A) 75 dB(A)
Schutzklasse IP rating	IP20
Signaltöne Alarm tones	Dauerton / Pulston continuous tone / pulse tone



Artikel /
Article

Bestellnummer /
Order number

Artikel /
Article

Bestellnummer /
Order number

PRODUKTVARIANTEN / PRODUCT VARIANT

LED-SIGNALSÄULE (D 40 mm) /
LED-SIGNAL TOWER (D 40 mm)

	Aufbausirene CO ST 40 / Sounder CO ST 40	6119373000
	Base 40 mm mit Deckel / Base 40 mm with cap	6119170000
	LED Element CO ST 40, 1F, rot / LED Element CO ST 40, 1F, red	6117423200

BESTELLNUMMERN ZUBEHÖR

	Gelenkfuss / Stand Foldable	6109070000
	Montagefuss 60 mm / Stand 60 mm	6109570000
	Montagefuss 110 mm / Stand 110 mm	6109670000
	Montagewinkel / Wall Mount	6109770000
	Verlängerungsrohr 250 mm / Extension Tube 250 mm	6109870000
	CO ST Schraubenset PM / CO ST Screwset PM	6109070060

Produktkatalog / catalog





Artikel /
Article

Bestellnummer /
Order number

Artikel /
Article





Bestellnummer /
Order number

PRODUKTVARIANTEN / PRODUCT VARIANT

LED-SIGNALSÄULE (D 40 mm) /
LED-SIGNAL TOWER (D 40 mm)

	Base 40 mm mit Deckel / Base 40 mm with cap	6119170000
	LED Element CO ST 40, 1F, rot / LED Element CO ST 40, 1F, red	6117423200
	Aufbausirene CO ST 40 / Sounder CO ST 40	6119373000

BESTELLNUMMERN ZUBEHÖR

	Montagefuss 60 mm / Stand 60 mm	6109570000
	Montagefuss 110 mm / Stand 110 mm	6109670000
	Montagewinkel / Wall Mount	6109770000
	Verlängerungsrohr 250 mm / Extension Tube 250 mm	6109870000
	Rohr mit Verschraubung / Panel Mount	6109970000
	CO ST Schraubenset PM / CO ST Screwset PM	610970060

Produktkatalog / catalog



ZUBEHÖR



Model CO ST STAND 60 oder 110

- MONTAGEFUSS | STAND
- ABS
- Höhe | height 60 / 110 mm
- No. 6109570000 [60 mm]
- No. 6109570000 [110 mm]



Model CO ST WM

- MONTAGEWINKEL | WALL MOUNT
- ABS
- Höhe | height 115 mm
- No. 6109770000



**Model CO ST PM SET
SCHRAUBENSET | SCREW SET**

- Mutter und Unterlegscheiben |
Nut and washers
- No. 6109070060



Model CO ST STAND F

- GELENKFUSS |
STAND FOLDABLE
- Gusseisen | cast iron
- Höhe | height 119,4 mm
- No. 6109670000



**Model CO ST TUBE-
VERLÄNGERUNGSRÖHR |
EXTENTIONS TUBE**

- ABS
- Höhe | height 250 mm
- No. 6109870000



Model CO ST PM

- ROHR MIT VERSCHRAUBUNG |
PANEL MOUNT
- ABS
- Höhe | height 70 mm
- No. 6109870000



MONTAGEFUSS 60 mm STAND 60 mm

ZUBEHÖR
ACCESSORIES

LED-SIGNALSÄULEN
LED-SIGNAL TOWERS

SPEZIFIKATIONEN | SPECIFICATIONS

Model	STAND 60 mm
Gehäusefarben Body colours	schwarz black
Material Construction	ABS ABS

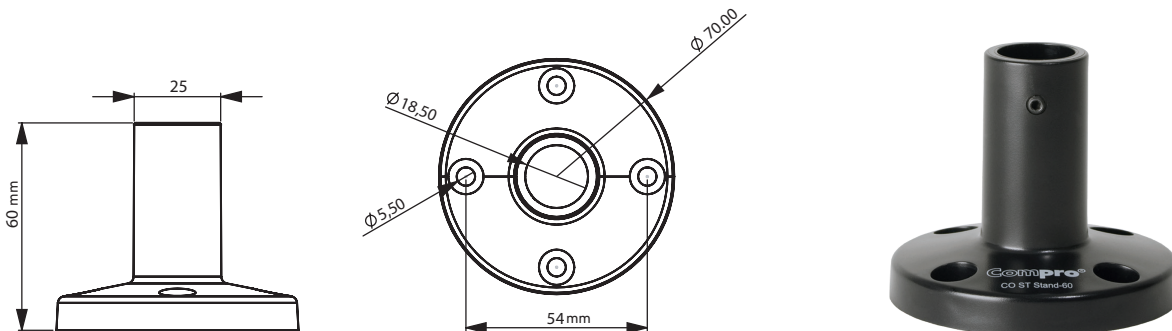

BESTELLNUMMERN / ORDER NUMBERS

	Montagefuß 60 mm / Stand 60 mm	6109570000
---	-----------------------------------	------------

BESTELLNUMMERN ZUBEHÖR ORDER NUMBERS ACCESSORIES

	Gelenkfuß / Stand Foldable	6109070000
	Montagefuß 110 mm / Stand 110 mm	6109670000
	Montagewinkel / Wall Mount	6109770000
	Verlängerungsrohr 250 mm / Extension Tube 250 mm	6109870000
	CO ST Schraubenset PM / CO ST Screwset PM	6109070060
	Rohr mit Verschraubung / Panel Mount	6109970000